



DS-TN02-01

VALVOLE MANUALI

Manual radiator valves

Serie Tondera

Valvole manuali utilizzabili per l'intercettazione dei fluidi negli impianti di riscaldamento. Tutte le valvole sono dotate di codolo con autotenuta in gomma per facilitare l'installazione.

Manual radiator valves for the interception of fluids in heating systems. All the valves are equipped with a tailpiece with rubber self-sealing to facilitate the installation.

ART. 0623 0625 0628
0629 0624 0651 0652

Valvole manuali attacco per tubo rame e multistrato
Manual radiator valves, connection for copper and multilayer tubes

ART. 0620 0622 0626
0627 0621 0667 0668

Valvole manuali attacco per tubo ferro
Manual radiator valves, iron tube connection



Valvole a squadra
Angled radiator valves



Valvole via dritta
Straight radiator valves



Valvole reverse
Reverse radiator valves



Valvole attacco verticale
destra e sinistra
*Double angled radiator valves
right and left*



Valvole attacco verticale
destra e sinistra per radiatori misti
*Double angled radiator valves
right and left for mixed radiators*



PRESTAZIONI

Fluidi d'impiego	Acqua, soluzioni glicolate
Percentuale di glicole max	30%
Max pressione d'esercizio	10 bar
Max Temp. d'esercizio	100°C

MATERIALI E CARATTERISTICHE TECNICHE

Corpo	Ottone stampato: CW617N UNI EN 12165
Calotta	
Componenti interni	Ottone trafilato: CW614N UNI EN 12164
Volantino	
Elementi di tenuta	Gomma EPDM PEROX

PERFORMANCE

Employed fluids	Water, antifreeze solutions
Max. percentage of glycol	30%
Max working pressure	10 bar
Max working temperature	100°C

MATERIALS AND TECHNICAL FEATURES

Body	Pressed brass: CW617N UNI EN 12165
Nut	
Inside components	Extruded brass: CW614N UNI EN 12164
Handwheel	
Seal elements	EPDM PEROX rubber

Diagrammi Diagrams

0623 0620 Valvole a squadra
Angled radiator valves

0624 0621 Valvole reverse
Reverse radiator valves

0625 0622 Valvole via dritta
Straight radiator valves

0628 0626 Valvole attacco verticale
0629 0627 *Double angled radiator valves*

0651 0667 Valvole attacco verticale per radiatori misti

0652 0668 *Double angled radiator valves for mixed radiators*

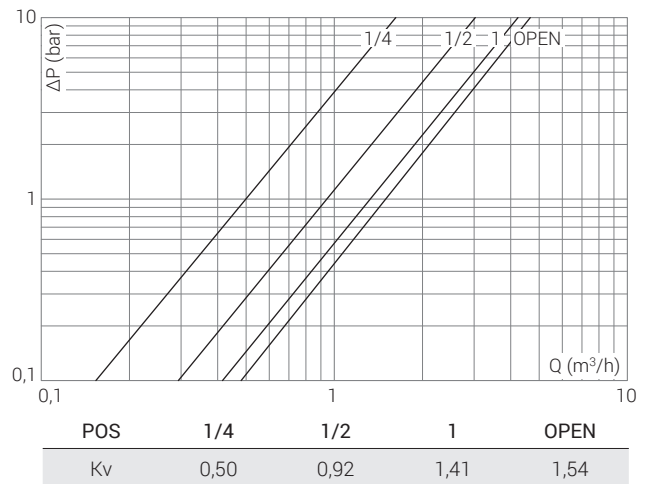
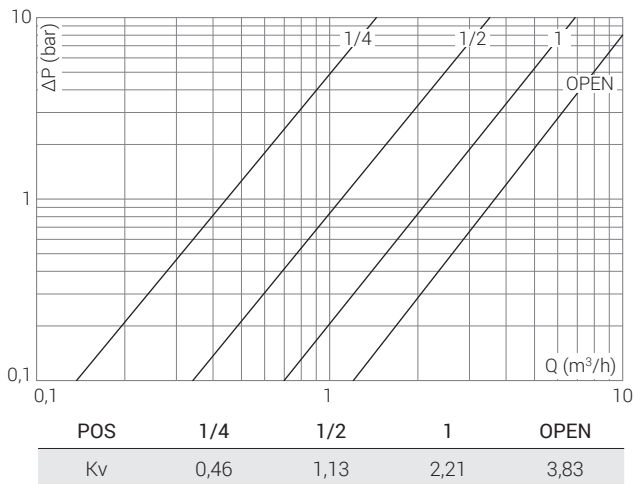

Istruzioni Instructions

Canapa - PTFE (Teflon)
Hemp - PTFE (Teflon)

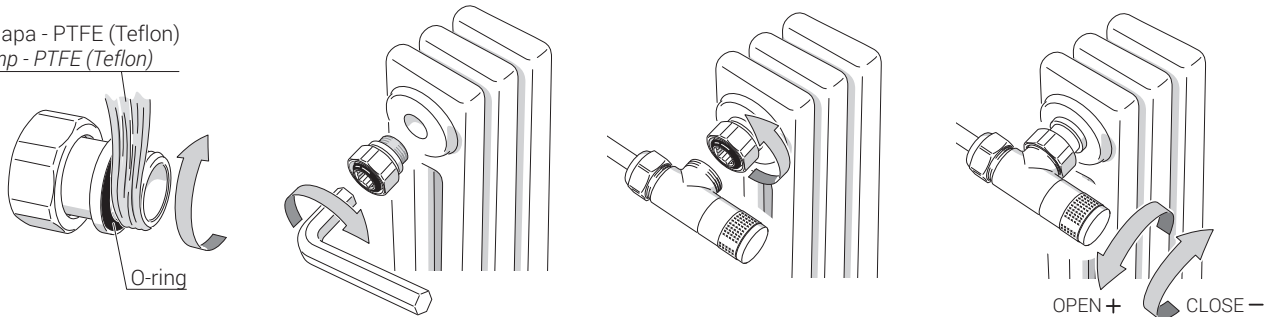

Installazione raccordi Connection installation

Art. 0481 - E481

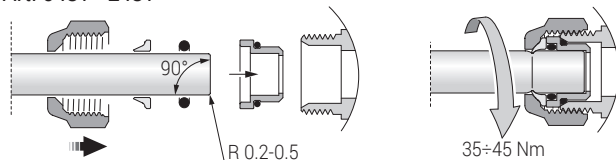

Art. 0483 - E483

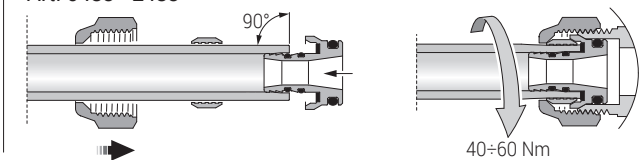

0623

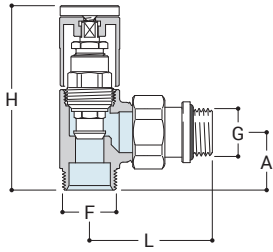

G	F	H	A	L
3/8"	24x19*	82	26	55
1/2"	24x19*	82	26	55

0625

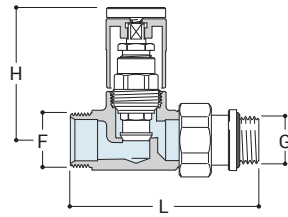

G	F	H	L
3/8"	24x19*	59	83
1/2"	24x19*	59	83

0624

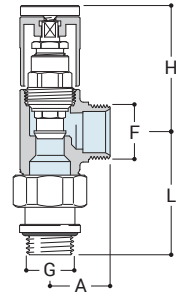

G	F	H	A	L
3/8"	24x19*	55	26	55
1/2"	24x19*	55	26	55

0628

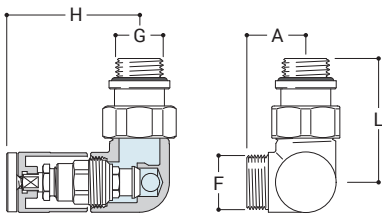

G	F	H	A	L
3/8"	24x19*	59	26	55
1/2"	24x19*	59	26	55

0629

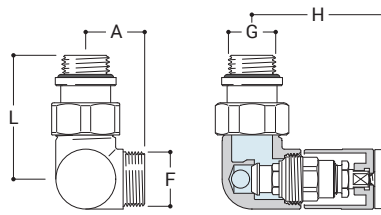

G	F	H	A	L
3/8"	24x19*	59	26	55
1/2"	24x19*	59	26	55

0651

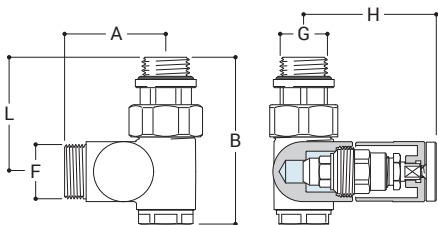

G	F	H	A	L	B
1/2"	24x19	59	45	52	73

0652

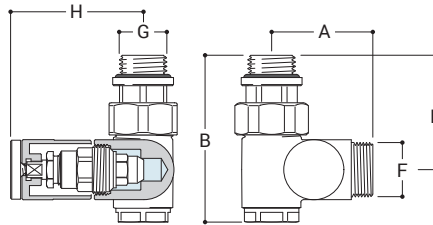

G	F	H	A	L	B
1/2"	24x19	59	45	52	73

0620

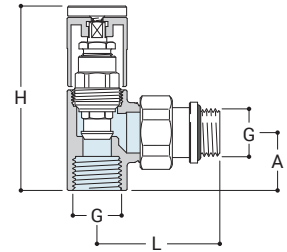

G	H	A	L
3/8"	82	26	55
1/2"	82	26	55

0622

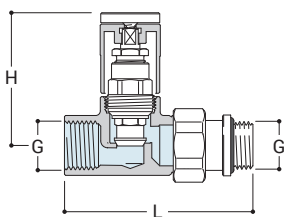

G	H	L
3/8"	59	83
1/2"	59	83

0626

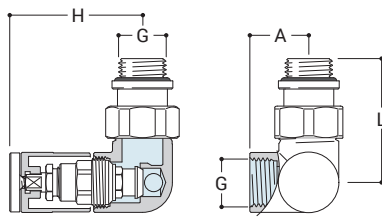

G	H	A	L
3/8"	59	26	55
1/2"	59	26	55

0627

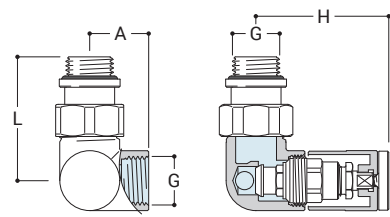

G	H	A	L
3/8"	59	26	55
1/2"	59	26	55

* = 3/4" E

0621

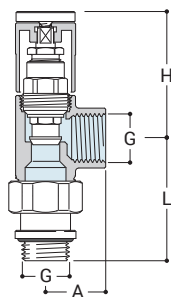

G	H	A	L
3/8"	55	26	54
1/2"	55	26	54

0667

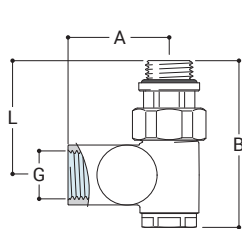

G	H	A	L	B
1/2"	59	45	52	73

0668

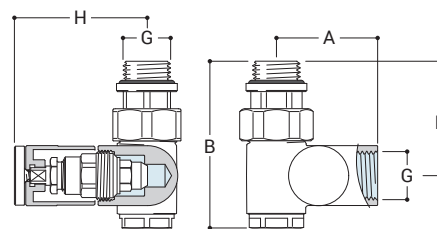

G	H	A	L	B
1/2"	59	45	52	73

Accessori Accessories



0481

Raccordo per tubo rame a tenuta O-Ring.
Copper tube connection with O-ring seal.



0483

Raccordo per tubo multistrato.
Multilayer tube connection.



E481 EUROCONO

Raccordo per tubo rame a tenuta O-Ring.
Copper tube connection with O-ring seal.



E483 EUROCONO

Raccordo per tubo multistrato.
Multilayer tube connection.



0301

Adattatore 1/2" F x 24/19 F.
Adaptor 1/2" F x 24/19 F.



0027

Prolunga per valvole (30 mm).
Extension for radiator valves (30 mm)



0030

Eccentrico per radiatori.
Cam for radiators.



0402

Codolo telescopico
Telescopic tailpiece



0031

Raccordo 1/2" con tubo saldato ø 15 mm.
1/2" connection with welded pipe ø 15 mm.



0490

Rosetta
Wall plate



0491

Kit copritubo tondo (2 pezzi).
Round pipe cover set (2 pcs).



A491

Kit di collegamento con rosoni tondi (2 pezzi), ø 15 mm, lunghezza 150 mm x 1/2".
Round connection set (2 pcs), ø 15 mm, length 150 mm x 1/2"

